

WiFi SMART GARAGE DOOR OPENER

MODEL:GD-DC5

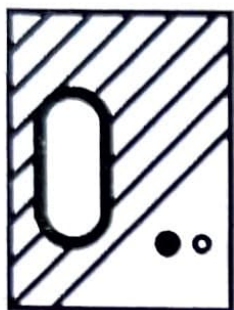

GD-DC5

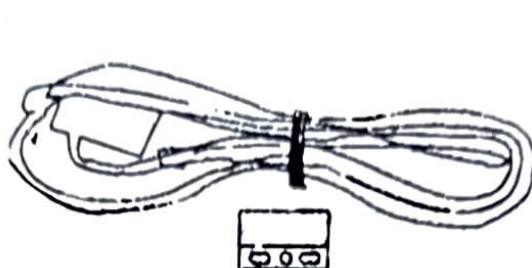

Door Sensor



2.0 2P Wire

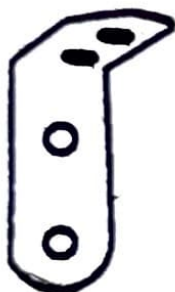

Braket

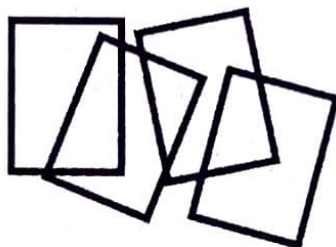

3M Gums



Line Holders



Ties

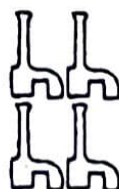

Wall Nails



Screws

Test Device For Opener Compatibility

- 1 Power up the GD-DC5 with your USB adapter and micro-USB cable. The Red LED will blink.
- 2 Use the included Red & Black wire connect the GD-DC5 to your opener: Put each end to the same terminals as the wall button wires are terminated to.
- 3 Use a tiny screw or nail to click the button in the GD-DCS, your garage door should activate.

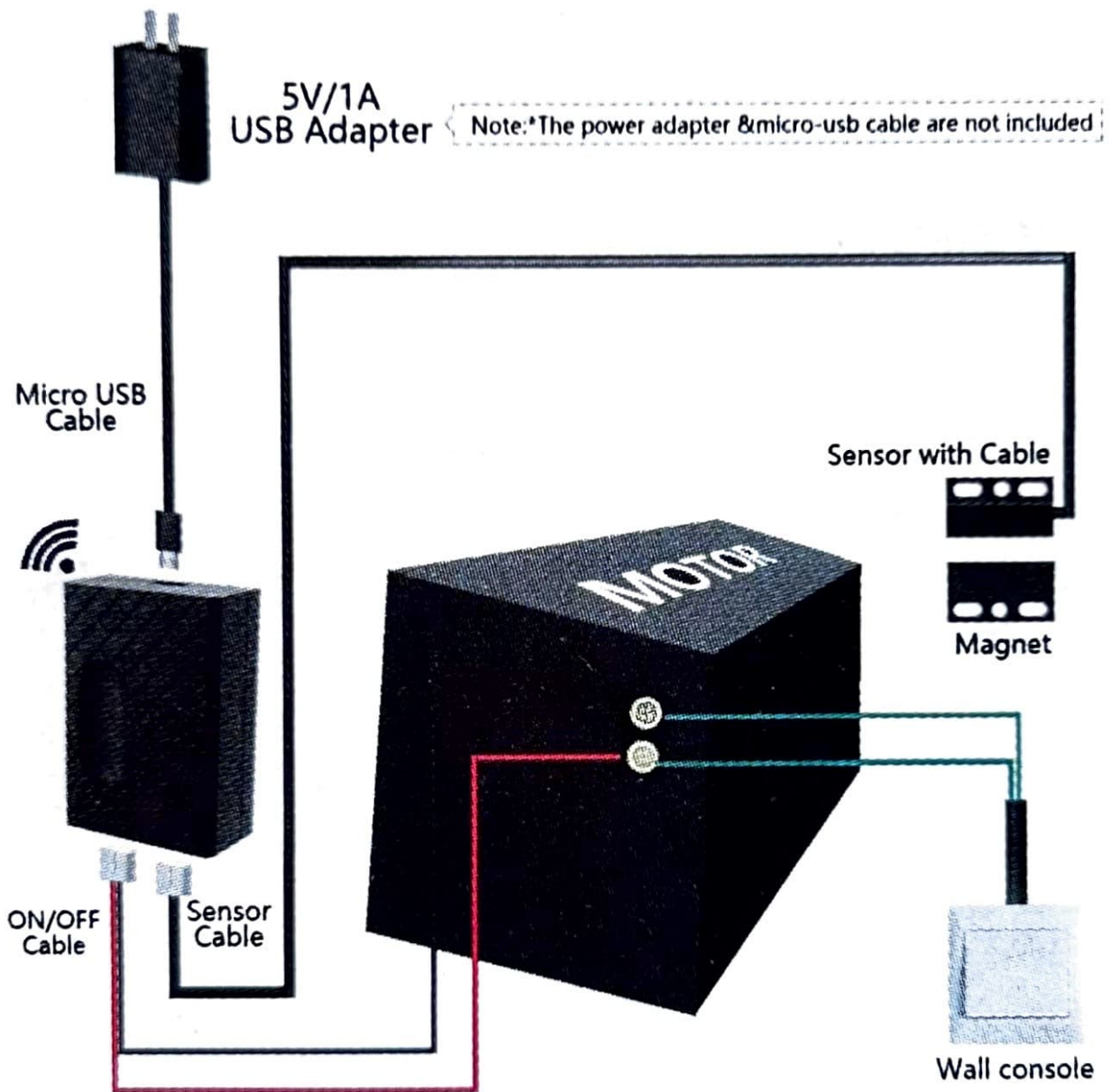

Test OK! Click the button every time, the garage door will open or close.

Below are checklist before using the device:

- Your smart phone or tablet should have connected a 2.4G WiFi with internet.
- The device only supports 2.4G Wi-Fi. If you use a 5G router (it provides two Wi-Fi signals: 5G and 2.4G), please select the 2.4G WiFi to connect your smart phone
- Download and launch the eWeLink App from App Store or Google Play store. Create an account or log in with your eWeLink account.
- During pairing process, make sure that your iOS or Android device and the GD-DC5 are within the range of your WiFi router.

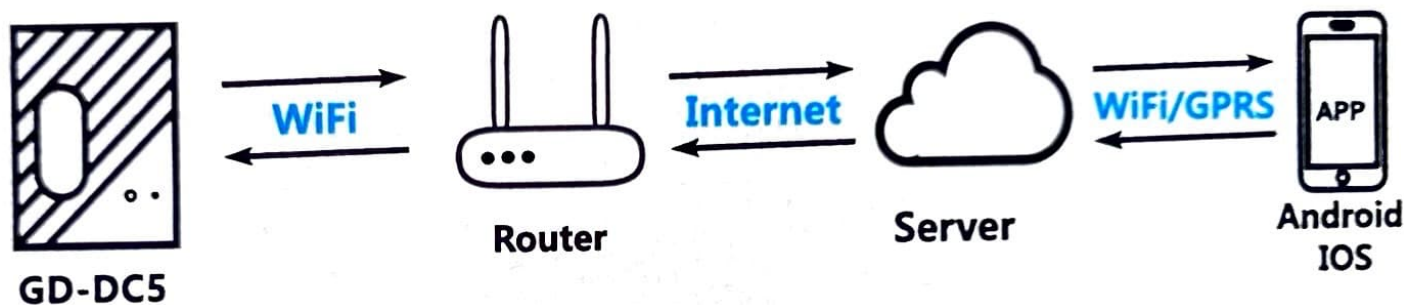

Add Device

- 1 Power up the GD-DC5 with your USB adapter, the Red LED will blink.
- 2 Use a tiny screw or nail to keep pressing the button in the GD-DC5 for 5s, until the Red LED blinks fast blinks 3 times and repeats.
- 3 Launch eWeLink. Select the icon  on the bottom to add a device. Then select Quick Pairing Mode (Touch), tap Next.

 @ Quick Pairing (Touch)

- 4 Select the same Wi-Fi as the one your mobile device connects with. Input correct passwords. Then, tap Next,
- 5 It will auto-connect with the device. The process will take 1-3 minutes, Once the process is complete, it will prompt you that you can rename the device. Enter a new name and Save.

if you fail to add it during the process, it will prompt you the FAQ.

OFF: The door is close.
You can tap the icon to turn on.

ON: The door is open.
You can tap the icon to turn off.

offline: Fail to control.
You can tap the "?" to read FAQ

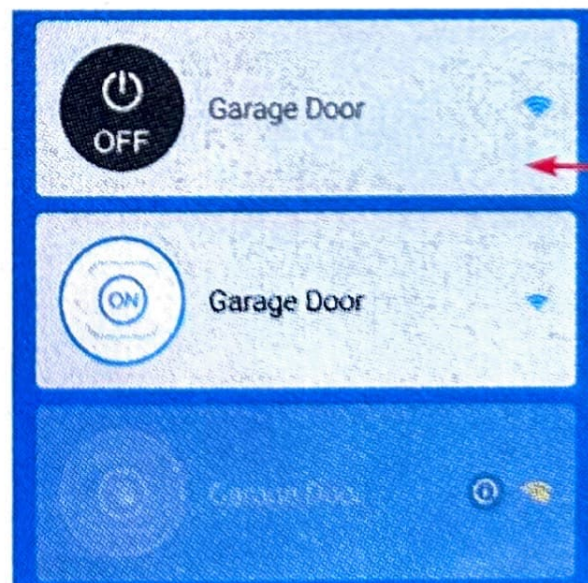

Tap here to enter the full function operation intertace.

10:30

Garage Door

Setting

Rename/Push notice/OTA

Delete

Remove from your account

History

Check the operation records



Tap to turn ON/OFF.
The blue background is ON.
The black background is OFF.



EASY INSTALLATION

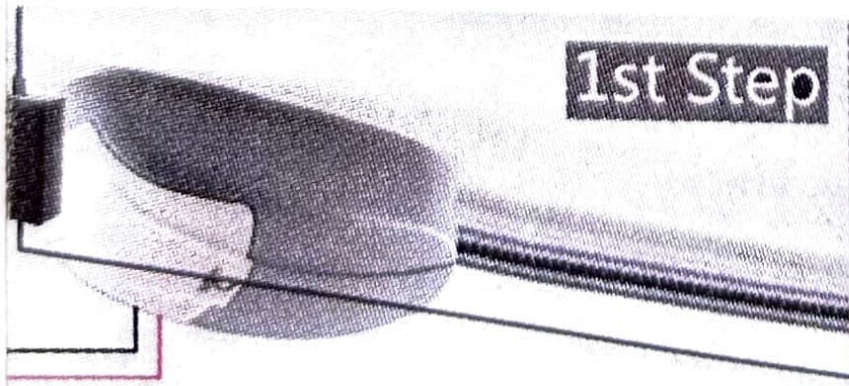
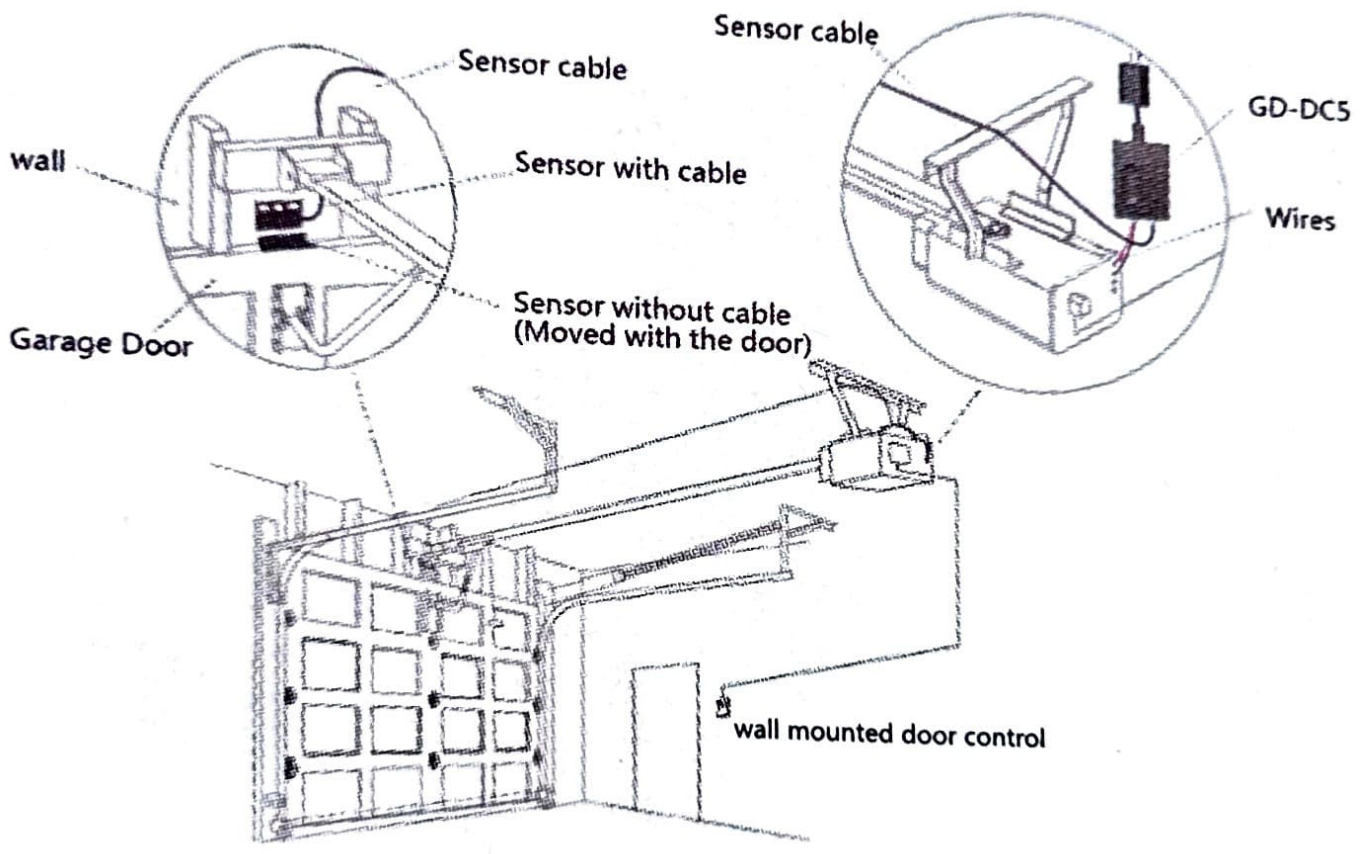

1st Step: Power up

The 5V USB adapter and micro USB cable are not included in the package, please use your own ones. **The 5V adapter should be more than 500mA output.**

2nd Step: Connect to the wall console

Insert the Red & Black wire 2.0mm terminal to the GD-DC5, then put each end to the same terminals as the wall button wires are terminated to.

3rd Step: Connect to the garage door

Insert the 2.0mm terminal of the sensor to the GD-DC5, then steady install the sensor and magnet of the gap within 3 mm to 15 mm on your garage door with screws/bracket/3M gums/wall nail/line holders/ties.

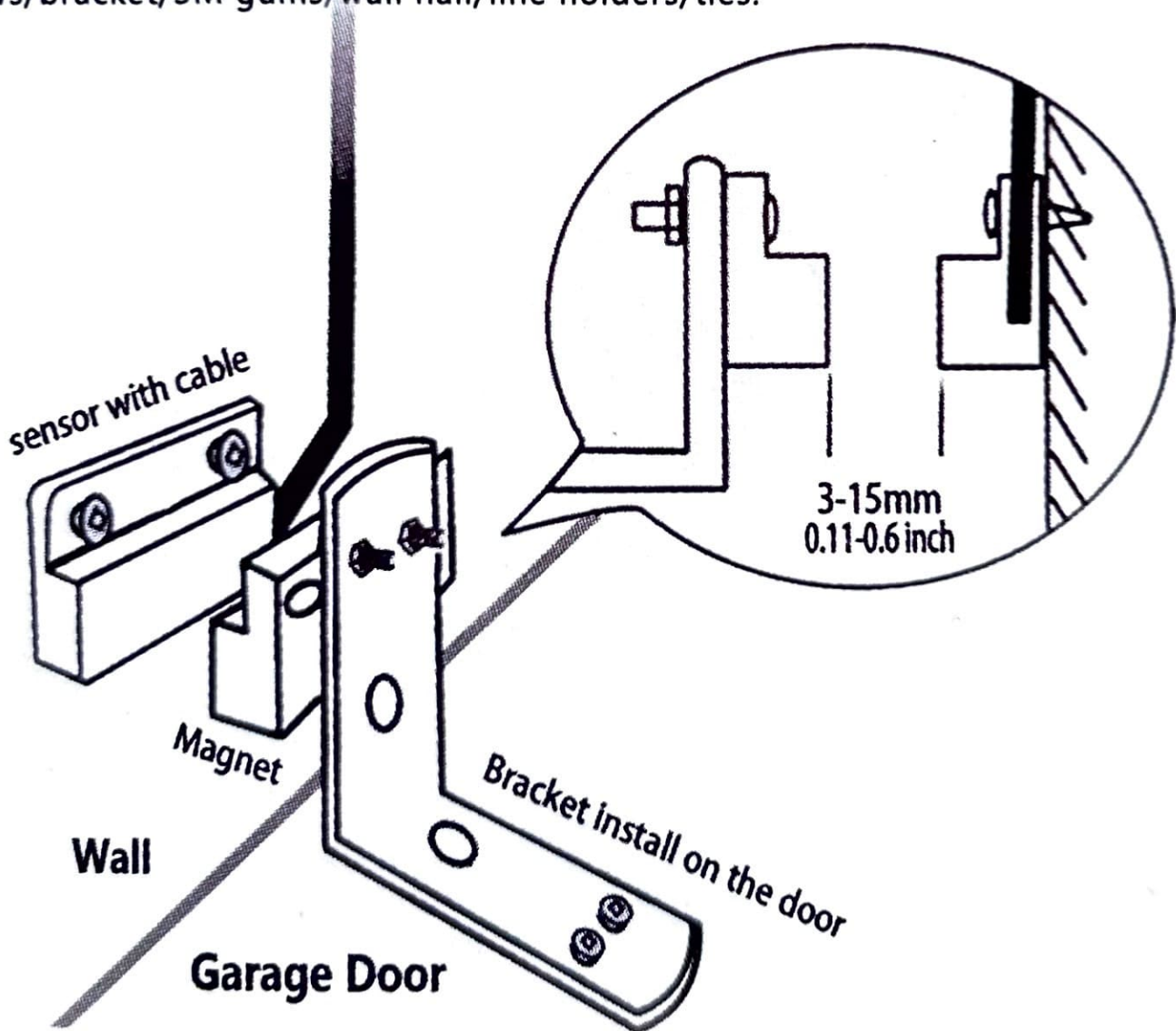

If it is hard to install with screws, you can also use the 3M gums to finish. If you are worried about the steady, you can use both screws and 3M gums.

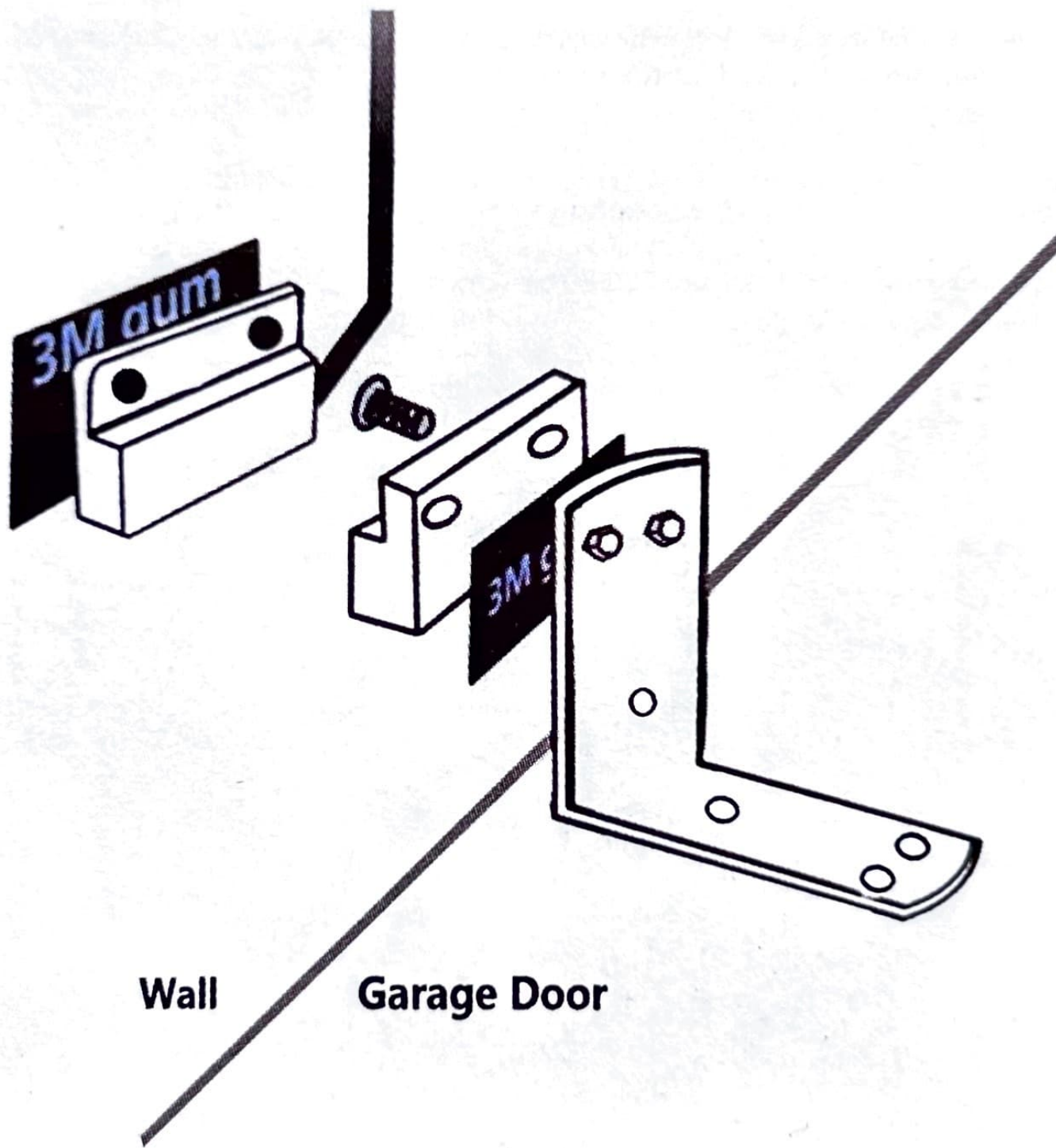

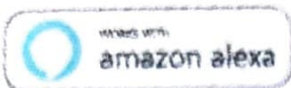

Works with Alexa



- 1 Open Alexa App, tap on the menu on upper left corner. Go to Skills.
- 2 Enter "eWeLink" (in full lowercase) in the Searchfield and search.
- 3 Tap "eWeLink Smart Home Fan".
- 4 Enable the skill.
- 5 Enter your eWeLink account information and tap on 'Log in' to link your eWeLink account to your Amazon account. If your account is a phone number, you should select your country. If your account is an email address, please select a random country/region code.

Voice commands:

- *Alexa, turn on {device name}*
- *Alexa, turn off {device name}*



Works with Google Home



- 1 Launch Google Home app, tap the menu.
- 2 Tap Home Control.
- 3 Under Devices, tap the + icon.
- 4 Tap Smart We Link.
- 5 Enter your eWeLink account email address/phone number, those phone number accounts need to select the right country code. Enter your password and tap Log In. If you eWeLink account is a Phone number, you should select your country. If your account is an email address, please select a random country/region code.

Voice commands:

- *Hey google, turn on {device name}*
- *OK google, turn off {device name}*



Works with IFTTT

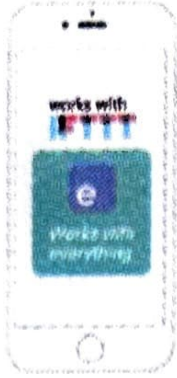

- 1 Launch IFTTT app, tap Search. Enter "eWeLink" to search. You'll find the "eWeLink Smart Home". Tap on it.
- 2 Enter "eWeLink Smart Home" page.
- 3 Then you'll need to enter eWeLink account and log in.
- 4 Go to My Applets, tap "+" to create your own applet.



Works with Google Nest



- 1 Open eWeLink.
- 2 Tap **+**, Select Nest Device, Next.
- 3 You'll need to log in your Nest account.
- 4 You'll enter into the Nest Device list. Check your desired nest device, confirm.
- 5 The device will be in eWeLink list.